

BEAM SAW MACHINE

ULTRA
SERIES

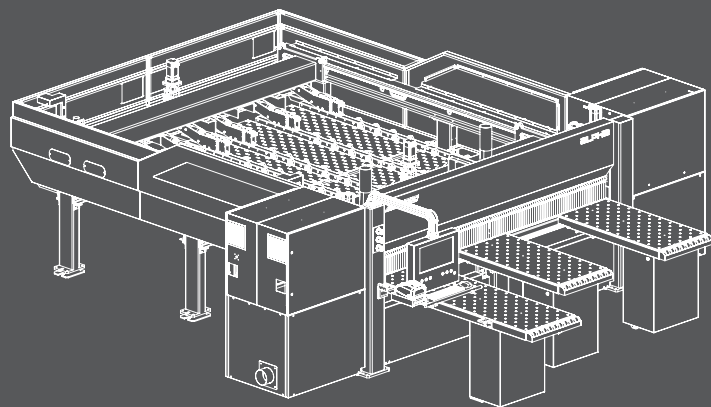

PANEL EBA TLAMA MAKINESI SECCIONADORAS



ALPHA



EN
TR
ES

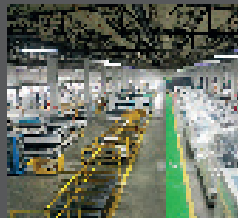
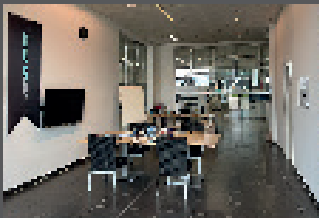
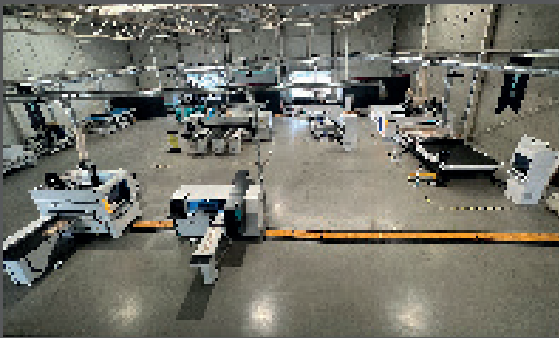
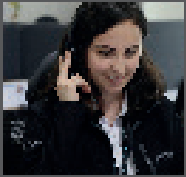
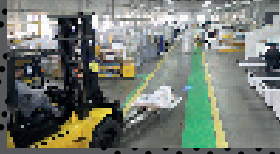
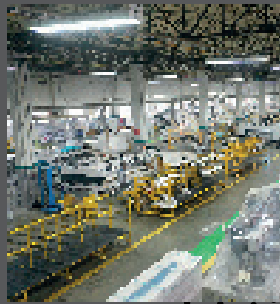
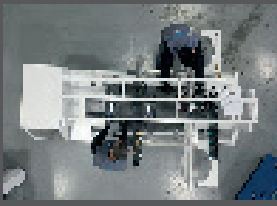

AES
AMERICA

Making its first overseas investment in the USA as the flagship of the Turkish woodworking machinery industry, AES continues to serve its customers in the North and South America through its center that was launched in Charlotte, North Carolina to provide sales and after-sales services.

Türk ahşap işleme sektörünün bayrak taşıyıcı firması olarak, ABD'de ilk yurt dışı yatırımını yapan AES satış ve satış sonrası hizmetleri için N.Carolina/Charlotte'da aktif hale getirdiği merkezi ile, Kuzey ve Güney Amerika'da hizmet vermeyi sürdürmektedir.

Haciendo su primera inversión en el extranjero en los EE. UU. como el buque insignia de la industria de maquinaria de carpintería turca, AES continúa sirviendo a sus clientes en América del Norte y del Sur a través de su centro que se inauguró en Charlotte, Carolina del Norte para brindar servicios de ventas y posventa.



As part of its policy to expand its sales and aftersales service network on an ongoing basis, AES has incorporated its affiliate AES Europe in Blitzen, Belgium with a view to providing better sales and aftersales services as well as technical support to its customers in Europe

Avrupa kıtasındaki müşterilerine daha iyi satış ve satış sonrası hizmet verebilmek amacıyla Bilzen/Belçika'da AES Europe'u kuran AES, müşterilerine teknik destek sağlarken satış ve servis ağını da her geçen gün büyümeye devam etmektedir.

Con el fin de brindar un mejor servicio de venta y posventa a sus clientes en el continente europeo, AES que estableció AES Europe en Bilzen/Bélgica, mientras brinda soporte técnico a sus clientes, continúa expandiendo su red de ventas y servicio día a día.



AES has been the flagship of the Woodworking Machinery industry in Turkey since the day of its incorporation in 1989, by redefining the sector with its in-house developed and designed state of the art products. Endeavoring its best efforts to get recognized among the leading manufacturers on a global scale, AES GROUP grows and continues to develop, through the centers it has launched worldwide and its global service network together with its valuable customers. We continue to be your global partner with a high production capacity, specialist staff and global sales and aftersales service network.

1989 yılında kurulduğu ilk günden bu yana Ahşap İşleme Makineleri sektöründe, geliştirdiği makineler ve tasarımlarla sektörü yeniden tanımlayan AES; Türkiye'nin sektördeki bayrak taşıyıcı firması olmaya devam ediyor. Kuruluş vizyonu doğrultusunda dünyanın sayılı üreticileri arasına girmek için çalışan AES GROUP dünya çapında açtığı merkezler ve kurduğu hizmet ağı ile; sizlerle büyüyor, büyürken de gelişmeye devam ediyor. Yüksek üretim kapasitesi, uzman kadrosu, küresel satış ve servis ağı ile her zaman global partneriniz olmaya devam ediyor.

AES, que ha redefinido la industria con las máquinas y diseños que ha desarrollado desde el primer día de su fundación en 1989, en la industria de las Máquinas de Procesamiento de Madera sigue siendo la empresa líder de Turquía. GRUPO AES, que trabaja para convertirse en uno de los principales fabricantes del mundo en línea con su visión de establecimiento, crece con ustedes con los centros que ha abierto en todo el mundo y la red de servicios que ha establecido, y sigue desarrollándose mientras crece. Sigue siendo su socio global con su alta capacidad de producción, personal experto, ventas globales y red de servicios.

your global partner

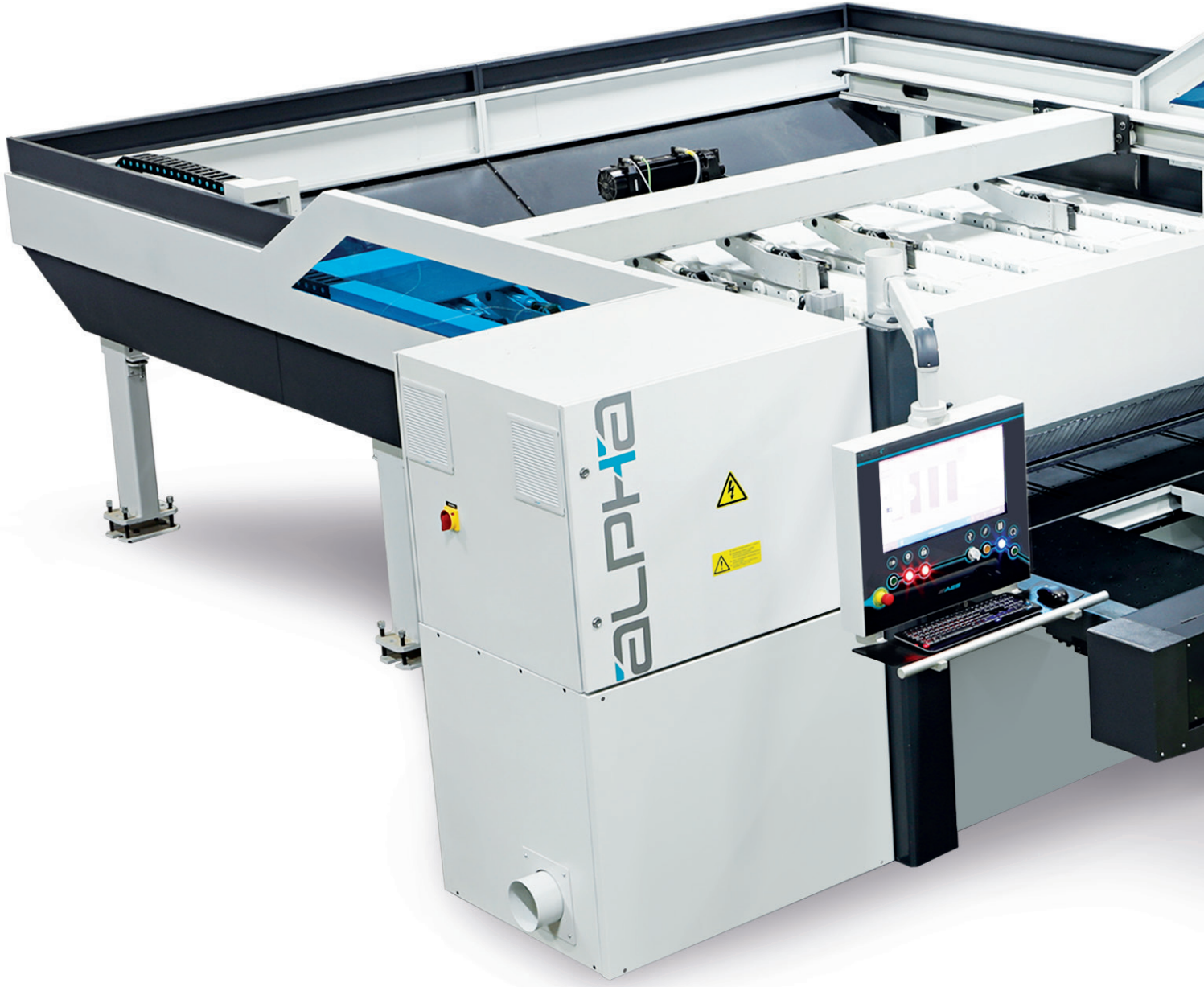

Ultra Power

Performance

Ultra güç, ultra performans
Ultra potencia Ultra rendimiento

ALPHA

ULTRA
SERIES

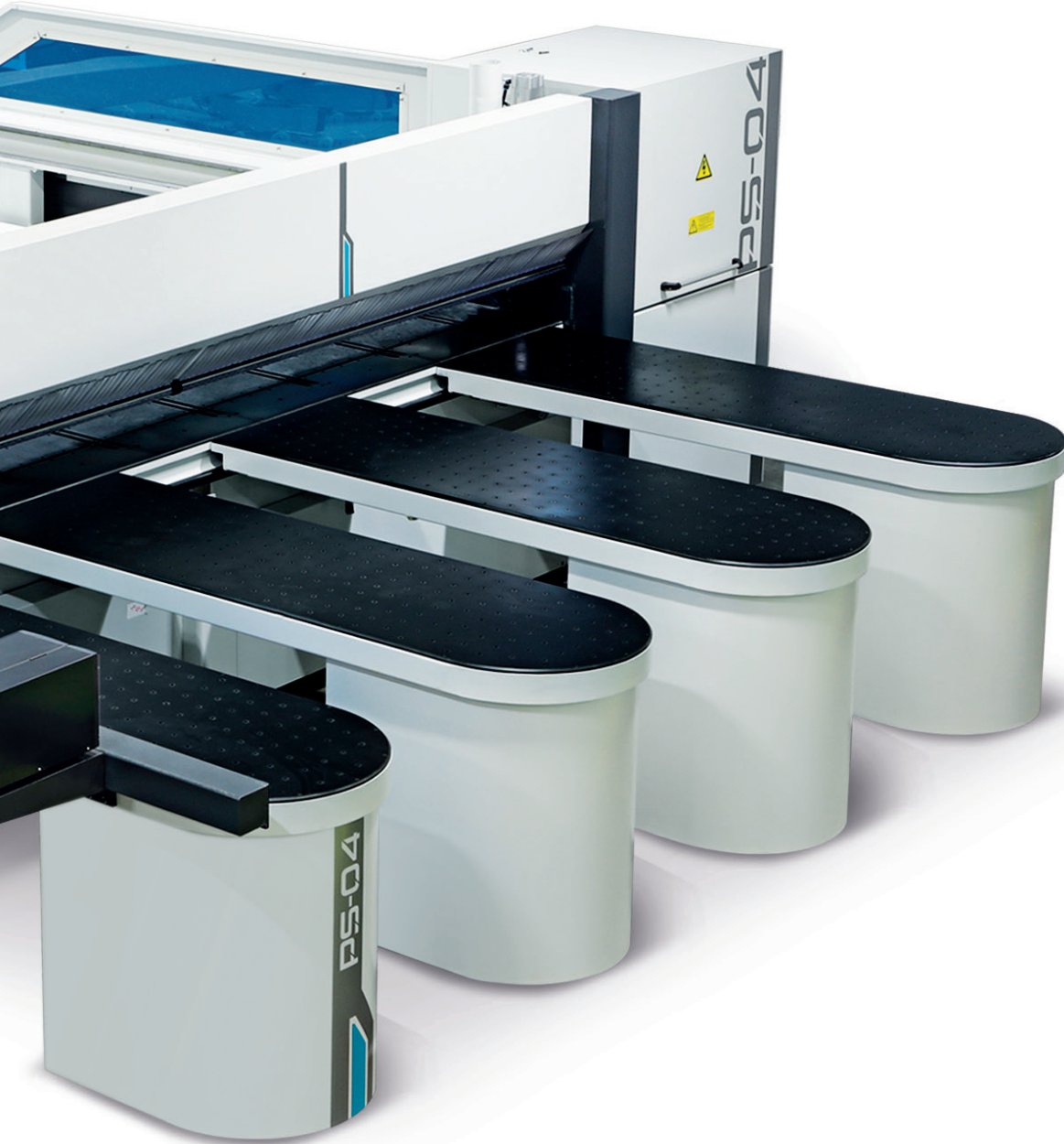

PS-03
PS-04

3300

3300 x 3300 mm

3900

3900 x 3900 mm

4300

4300 x 4300 mm

EN

Our ULTRA series machinery offers industrial solutions to provide maximum performance even for the most delicate designs and processes. The ULTRA series will support you for all your needs with its flexible configuration, optimizing operation speed and precision allowing for excellent acceleration. It ensures that you achieve the best machining results you could imagine thanks to its body structure eliminating even the slightest vibrations.

TR

Endüstriyel çözümler sunan ULTRA serisi makinelerimiz ile en hassas tasarım ve işlemlere dahi tam performans çözümler sunar. Esnek konfigürasyonu sayesinde tüm ihtiyaçlarınız için yanınızda olan ULTRA serisi; makine çalışma hızı ve hassasiyetini optimum seviyeye çıkararak mükemmel ivmelenmeye olanak sağlar. En küçük vibrasyonun dahi engellendiği gövde yapısı sayesinde işleme esnasında size hayalinizdeki sonucu garanti eder.

ES

Con nuestras máquinas de la serie ULTRA que ofrecen soluciones industriales, ofrecemos soluciones de rendimiento completo incluso para los diseños y procesos más sensibles. Gracias a su configuración flexible, serie ULTRA, que le apoya para todas sus necesidades, proporciona una excelente aceleración al optimizar la velocidad de trabajo y la precisión de la máquina. Gracias a su estructura del cuerpo que evita hasta la mínima vibración, le garantiza el resultado de sus sueños durante el procesamiento.

Models
Modeller
Modelo

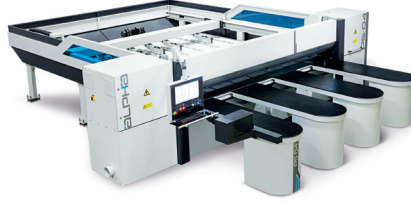

LEADER PACK THE

Alpha beam saw machine is designed to perform panel processing applications in the most efficient manner. It guarantees precise and error-free results thanks to its strong body and fast structure.

Alpha Panel Ebatlama makinesi, panel işleme uygulamalarını en verimli şekilde yapmak için tasarlanmıştır. Güçlü gövde ve hızlı yapısı ile hassas ve hatasız sonuçları garanti eder.

Alpha La máquina con seccionadoras está diseñada para realizar aplicaciones de procesamiento de paneles de la manera más eficiente. Garantiza resultados precisos y sin errores gracia a su cuerpo fuerte y estructura rápida.

FIELD OF APPLICATIONS UYGULAMA ALANLARI CAMPO DE APLICACIONES



CLOSET ROOM



FURNITURE



DOOR



BATHROOM



FURNITURE



FURNITURE



GROOVING



KITCHEN



GROOVING

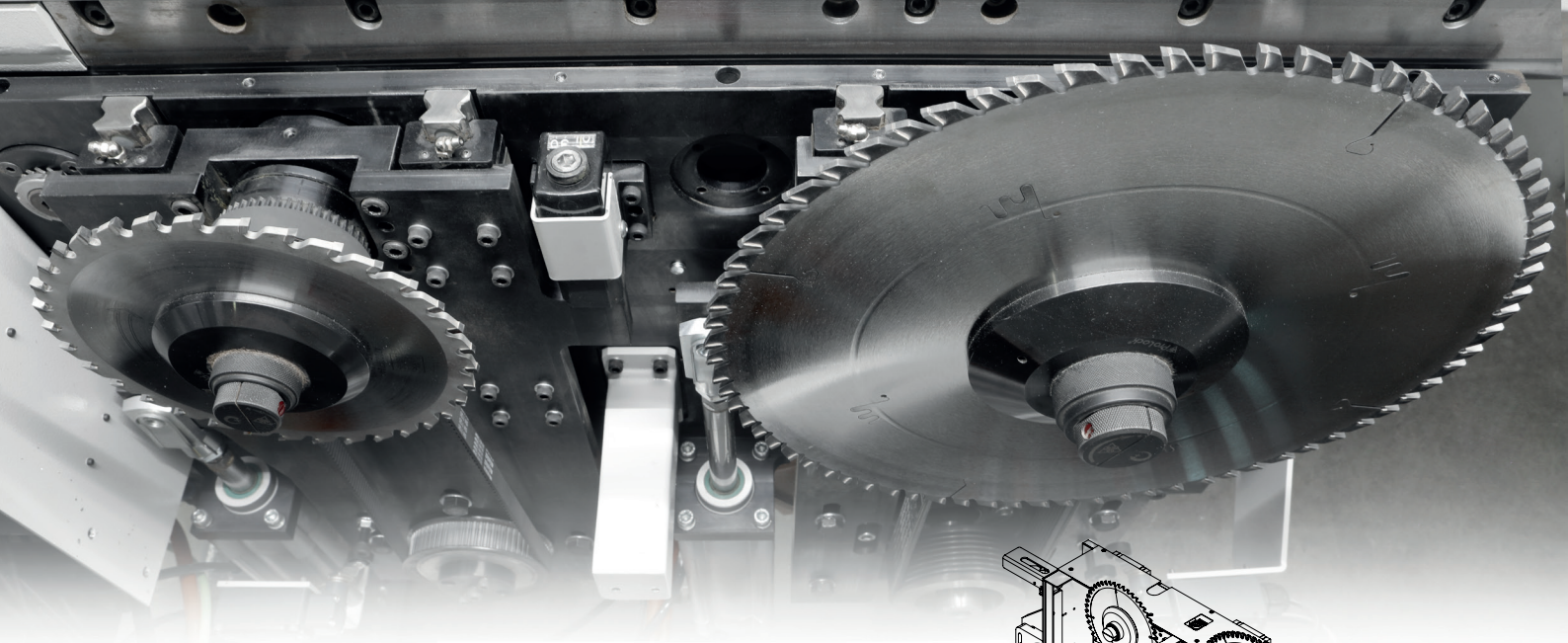

HIGH PERFORMANCE SAW CARRIAGE UNIT

YÜKSEK PERFORMANSLI TESTERE ÜNİTESİ

UNIDAD DE SIERRA DE ALTO RENDIMIENTO

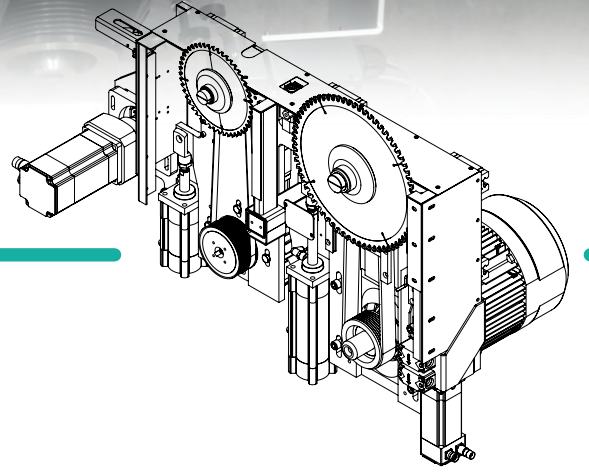

EN With a saw blade motor of 11 or 15 kW, 2,2 kW scoring saw motor ensures fast, precise and safe cutting. It works optimally with minimum cost with its strong structure.

TR 11 ve 15 kW işleme gücüne sahip testere grubu ile, 2,2 kW çizici testere motoru hızlı, hassas ve güvenli kesimi garanti eder. Güçlü yapısı ile minimum maliyet ile optimum şekilde çalışır.

ES Con su grupo de sierra que tiene potencia de procesamiento 11 y 15 kW, el motor de sierra de trazador 2,2kW garantiza un corte rapido, preciso y seduro. Funciona optima a un coste mínimo con su estructura potente

FAST & PRACTICAL SAW CHANGE

HIZLI & PRATİK TESTERE DEĞİŞİMİ

RÁPIDO Y PRÁCTICO CAMBIO DE SIERRA

High Performance Perfect Result

Yüksek performans, mükemmel sonuç

Excelente resultado con alto rendimiento

EN Additional options for grooving operations.

TR Kanal açma özelliği işlemleriniz için ek opsiyonlar

ES Opciones adicionales para las operaciones de función de apertura de canal



GRIP SYSTEM OFFERING EXCELLENT PRECISION

MÜKEMMEL HASSASIYET SUNAN TUTUCU SİSTEM

SISTEMAS DE PORTADOR QUE GARANTIZA LA PRECISIÓN DE ALTO NIVEL

EN

The powerful and high-performance pusher bridge is designed with a steel structure for precise positioning of the plates to be machined. There are 8 standard grippers on the unit.

TR

Güçlü ve yüksek performanslı taşıyıcı köprü işlemeye alınacak plakaların hassas pozisyonlanması için çelik köprü yapısı ile tasarlanmıştır. Ünite üzerinde 8 adet standart tutucu bulunur.

ES

El puente empujador potente y de alto rendimiento está diseñado con una estructura de acero para un posicionamiento preciso de las placas que se procesarán. Hay 8 abrazaderas estándar en la unidad.

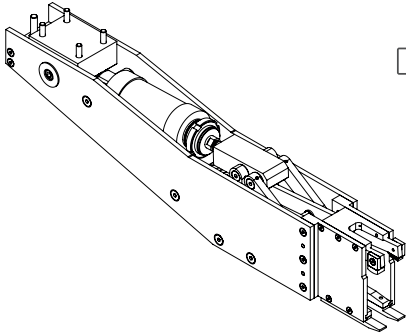

Double Finger System
Çift Tırnak Tutucu
Sistema De Doble Dedo

Barcode Printer
Barkod Yazıcı
De Código De Barras

AIR FLOATING WORKING TABLE FOR EASY LOADING

KOLAY YÜKLEME İÇİN HAVA YÜZDÜRMELİ TABLA

MESA FLOTANTE DE AIRE PARA FACILITAR LA CARGA

EN

The working table on Alpha allows for easy loading and unloading with its ergonomic structure.

TR

Alpha'da bulunan çalışma tablası ergonomik yapısı ile kolay yükleme ve boşaltmaya imkan sağlar.

ES

La mesa de trabajo en Alpha permite cargar y descargar fácilmente con su estructura ergonómica.



CENTRAL LUBRICATION UNIT
Automatically lubricates the main components in 21 different zones

MERKEZİ YAĞLAMA ÜNİTESİ
21 farklı bölgede ana aksamların otomatik olarak yağlanmasını sağlar.

UNIDAD CENTRAL DE LUBRICACIÓN
Permite la lubricación automática de los componentes principales en 21 regiones diferentes.



AXIS CONTROL WITH SERVO MOTORS
State of the art motors located on each axis ensure precise acceleration at high speed

SERVO MOTORLAR İLE EKSEN KONTROLÜ
Tüm eksenlerde bulunan son teknoloji ürün motorlar, yüksek hızlarda hassas ivmelenme sağlar

CONTROL DE EJES CON SERVOMOTORES
Los motores de última generación en todos los ejes proporcionan una aceleración precisa a altas velocidades

Details Considerate for your Business

İşiniz için
düşünmüş detaylar
Detalles considerados
para su negocio

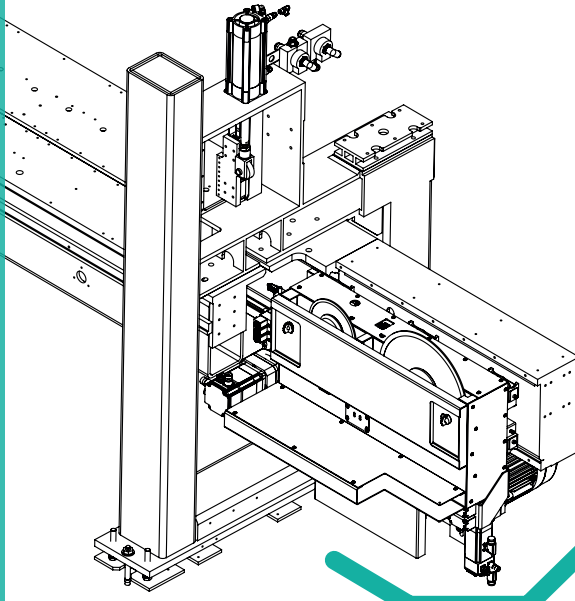

EXCELLENT ALIGNMENT

MÜKEMMEL HİZALAMA

EXCELENTE ALINEACIÓN

EN The side aligner unit is used to align the aprts to be cut. The unit aligns area between 50 - 1.850 mm.

TR Yan parça dayama kesilecek parçaların hizlamasını yapmak için kullanılır. Ünite 50 - 1.850 mm. alanda hizalama yapmaktadır.

ES Se usa para la alineación de las piezas que se cortaran con soporte lateral. La unidad hace la alineación en un área de 50 - 1.850 mm.

STRONG BODY GÜÇLÜ GÖVDE

CUERPO FUERTE

EN The machine body is made of fully vibrated steel, its strong body structure allows for smooth production even under the most challenging conditions

TR Makine gövdesi tamamen titreşimi alınmış çelikten üretilmiştir, güçlü gövde yapısı en zorlu şartlarda dahi sorunsuz üretim yapılabilmesine imkan sağlar.

ES La carrocería de maquina esta fabricada de un acero no vibrantes completamente y su carrocería potente permite que se haga producción aun bajo las condiciones mas dificultades.

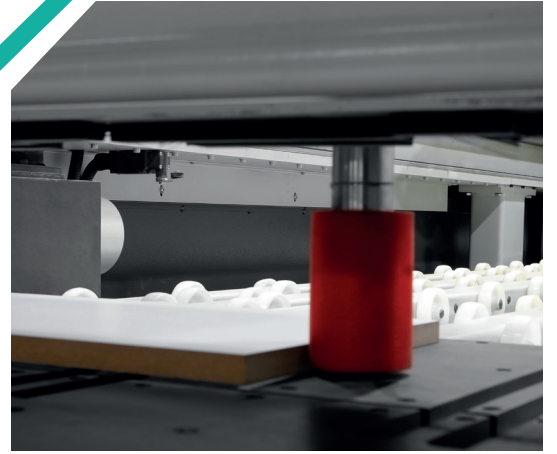

UNINTERRUPTED PRODUCTION WITH THE LIFT UNIT

LİFT ÜNİTESİ İLE KESİNTİSİZ ÜRETİM

PRODUCCIÓN ININTERRUM- PIDA CON LA UNIDAD DE ELEVACIÓN

EN The lift unit option offered on the Alpha allows you to keep plates ready for the processing sequence. The lifting unit positioned on the side of the table has a load capacity of 500 mm. Elevator parts are easily carried onto the air float at table. In this way, operator safety and time savings are guaranteed.

TR Alpha'da sunulan lift ünite opsiyonu; plakaları işlem sırası için hazır tutmanızı sağlar Tablanın yan tarafına konumlandırılan lift ünitesi 500 mm yüklem kapasitesine sahiptir. Lift üzerindeki parçalar kolayca hava yüzdürmeli tabla üzerine alınır. Böylece zaman tasarrufu ile birlikte operatör güvenliği sağlanmış olur.

ES La opción de unidad de elevación que se ofrece en Alpha le permite mantener las placas listas para la secuencia de procesamiento. La unidad de elevación posicionada en el lateral de la mesa tiene una capacidad de carga de 500 mm. Las piezas del elevador se llevan fácilmente a la mesa de flotante de aire. De esta manera, se garantizan la seguridad del operador y el ahorro de tiempo.

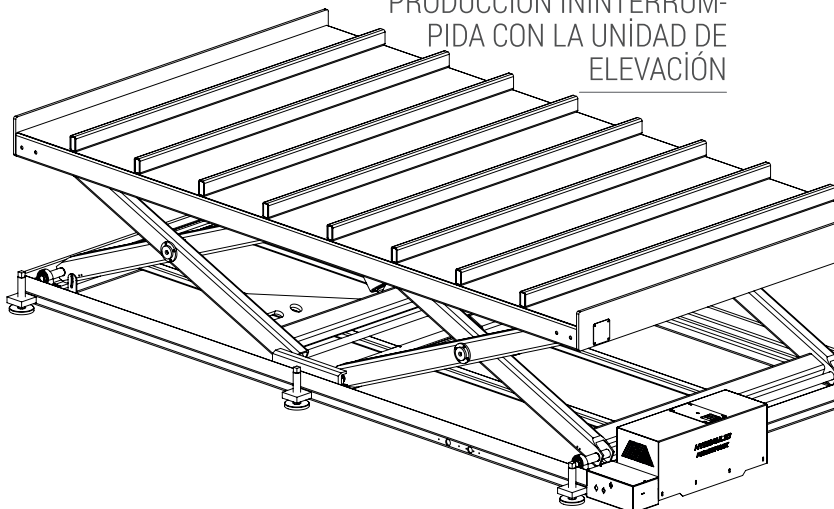



USER EXPERIENCE / KULLANICI DENEYİMİ / EXPERIENCIA DE USUARIO



"As easy to use as a mobile phone"
"Telefon kullanmak kadar kolay."
"Tan fâcil como usar un telefono"

"The machine helps us to perform machining operations accurately by guiding us with warning messages."

"Uyarılar bizi yönlendirerek, doğru işlem yapmamıza destek oluyor."

"Las alertas nos orientan y nos ayudan a realizar la acción correcta."

NEXT GENERATION CONTROL CENTER

YENİ JENERASYON KONTROL MERKEZİ

UNIDAD DE CONTROL DE ÚLTIMA GENERACIÓN

EN

The next generation control unit is powered by a PC designed for industrial operations. It allows you to make your transactions quickly and easily without getting stuck.

TR

Endüstriyel işler için üretilen PC'den gücünü alan yeni jenerasyon kontrol ünitesi. İşlemlerinizi takılmadan, hızlı ve kolay gerçekleştirmenizi sağlar.

ES

Unidad de control de nueva generación alimentada por PC fabricada para trabajos industriales. Le permite realizar sus transacciones de forma rápida y sencilla sin quedarse atascado.

Our aftersales support team is always there for you when you need them thanks to the remote control feature of ALPHA.

ALPHA'nın uzaktan kontrol özelliği ile, ihtiyaç duyduğunuz her an satış sonrası destek ekibimiz yanınızda

Gracias a la función de control remoto de ALPHA, nuestro equipo de soporte posventa le apoya siempre que lo necesite.

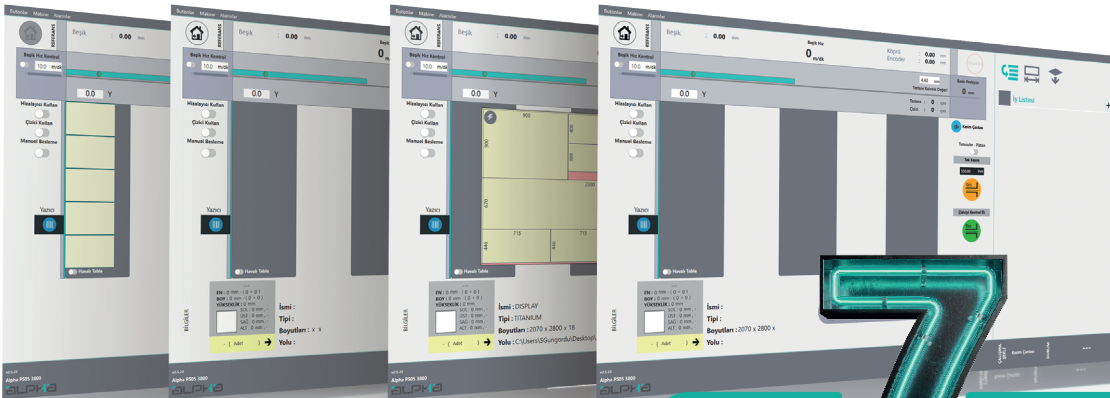
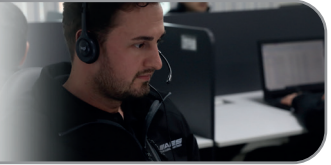

7

LANGUAGE DİL SEÇENEĞİ

OPCIONES DE IDIOMA

TR / EN / AR / RU / ES / FR / NL

Control Unit
Kontrol Ünitesi
Unidad De Control



Design freely



MINIMUM LOSS WITH ADVANCED PANEL OPTIMIZATION

GELİŞMİŞ PANEL OPTİMİZASYONU İLE MINIMUM FİRE

DESPERDICIO MINIMO LA OPTIMIZACION DE PANELES AVANZADA

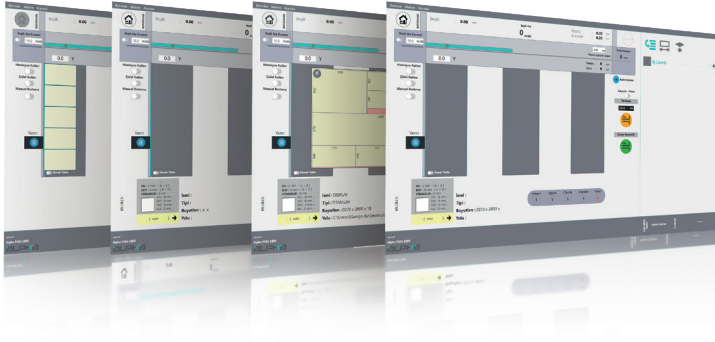

EN

Make your production with a minimum loss with panel optimization algorithm, with minimum waste.

TR

Gelişmiş panel optimizasyon motoru kesim yapılacak plakanın yerleşimini optimum seviyede, minimum fire oranı ile gerçekleştirir.

ES

El motor de optimización de panel avanzado realiza la colocación de la placa a cortar en el nivel óptimo con el mínimo desperdicio.

ERROR-FREE PRODUCTION WITH MACHINE & CUTTING SIMULATION

MAKİNE VE KESİM SİMÜLYASYONU İLE HATASIZ ÜRETİM

PRODUCCION CORRECTA CON LA SIMULACION DE MAQUINA Y DE CORTE

EN

You can make error-free production with part cutting simulation. With machine simulation, you can monitor axis movements, gripper and driver positions simultaneously from the control screen.

TR

Parça kesim simülasyonu ile hatasız üretim yapabilir, makine simülasyonu ile eksen hareketleri, tutucu ve sürücü pozisyonlarını kontrol ekranından eş zamanlı olarak izleyebilirsiniz.

ES

Puede realizar una producción sin errores con la simulación de corte de piezas. Con la simulación de máquina, puede monitorear los movimientos de los ejes, las posiciones de las pinzas y del conductor simultáneamente desde la pantalla de control.



DESIGN
TASARLA
DISEÑO



TRANSFER
TRANSFER ET
TRANSFERIR



PRODUCE
ÜRET
PRODUCCIÓN

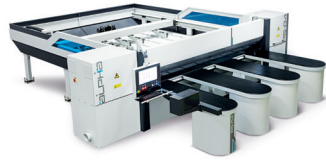

TECHNICAL INFORMATION

TEKNİK ÖZELLİKLER

ESPECIFICACIONES TÉCNICAS

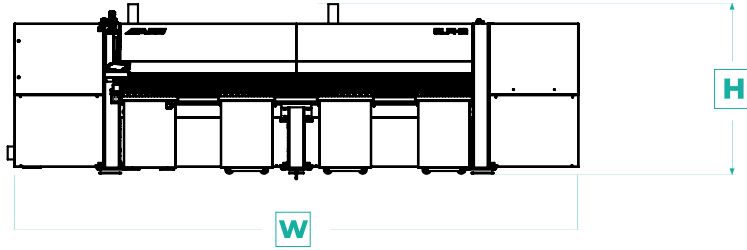
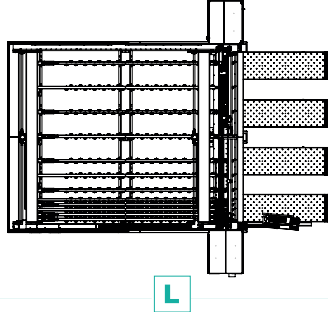

		L	W	H
ALPHA PS03/04 3300	mm / inch	7070 / 278.34	7000 / 275.59	
ALPHA PS03/04 3900	mm / inch	7670 / 301.96	6400 / 251.96	2007 / 79.02
ALPHA PS03/04 4300	mm / inch	8070 / 317.72	6000 / 236.22	



		A	B	C	D
Cutting Head Kesim Yüksekliği Alto De Corte	mm / inch	70 / 2.75	55 / 2.16	90 / 3.54	75 / 2.95

ALPHA PS-03

ALPHA PS-04

3300

3900

4300

3300

3900

4300

	3300	3900	4300	3300	3900	4300
Working Area Dimensions Çalışma Alanı Ölçüleri Mediciones del Área de Trabajo	3300 mm 130"	3900 mm 154"	4300 mm 169"	3300 mm 130"	3900 mm 154"	4300 mm 169"
Main Saw Motor Power Testere Motor Gücü Potencia de Motor de Sierra		11 kW 15 HP			15kW 20 HP	
Scoring Saw Motor Power Çizici Motor Gücü Potencia de Motor de Trazador			2.2 kW 3 HP			
Pusher Working Speed Çalışma Hızı Velocidad de Trabajo			80 m/dk 3149 IPM			
Saw Carriage Speed Testere Kesim Hızı Velocidad de Corte			90 m/dk 3543 IPM			
Cutting Saw Diameter Kesici Takım Çapı Diametro de Herramientas de Corte		350 mm 13.77"			380 mm 14.96"	
Scoring Saw Diameter Çizici Testere Çapı Diametro de Herramientas de Trazador			200 mm 7.87"			
Optimization Program Optimizasyon Programı Programa de Optimización			AESCUT& OPTICUT & ARDIS			
Number of Clamps Tutucu Sayısı Número de Portadores			8 Pcs 8 Adet			

* The technical specifications and drawings provided in the catalogue are non-binding. Stock images and drawings may contain optional equipment. AES Group reserves the right to make amendments without notice.

* Katalogda bulunan teknik özellikler ve çizimler bağlayıcı değildir. Bazı fotoğraflar ve çizimler opsiyonel ekipmanları içerebilir. AES Group bilgilendirme yapmaksızın değişiklik yapma hakkını saklı tutmaktadır.

* Las especificaciones técnicas y dibujos del catálogo no son vinculantes. Algunas fotos y dibujos pueden incluir equipamientos opcionales. Grupo AES se reserva el derecho de realizar cambios sin previo aviso.



24/7 0850 22 77 **AES**
CALL CENTER
CENTRO DE LLAMADAS

ALWAYS WITH YOU

DAİMA YANINIZDA

SIEMPRE CON USTED



EN

Our specialist aftersales service staff is at your service 24/7 for all your needs. We attend to your problems expeditiously through accurate diagnosis by instant remote connection or servicing at your premises to ensure unconditional customer satisfaction. AES Group protects your investments with its aftersales service, ensuring uninterrupted production.

TR

Uzman satış sonrası hizmet kadromuz, tüm ihtiyaçlarınız için 7 gün 24 saat hizmetinizde. Daimi memnuniyet için, gerek anlık uzak bağlantı ile gerekse yerinde servis hizmeti ile en kısa zamanda doğru teşhis ile müdahale sağlar. AES Group, satış sonrası hizmetleri ile yatırımlarınızı koruyarak kesintisiz üretim yapmanıza destek olur.

ES

Nuestro personal experto en servicio posventa está dispuesto por las 24 horas, y los 7 días de la semana para todas sus necesidades. Para su satisfacción permanente, permite intervención con el diagnóstico correcto lo antes posible con conexión remota instantánea y servicio en el sitio. Grupo AES apoya su producción ininterrumpida protegiendo sus inversiones con sus servicios postventa.



REMOTE AND ON-SITE SERVICE SERVICES

UZAKTAN VE YERİNDE SERVİS HİZMETLERİ

SERVICIOS DE MANDO A DISTANCIA Y LUGAR



TRAINING AND INSTALLATION SERVICES

EĞİTİM VE KURULUM HİZMETLERİ

SERVICIOS DE FORMACIÓN E INSTALACIÓN



SPARE PARTS AND SALES SUPPORT

YEDEK PARÇA VE SATIŞ DESTEĞİ

PIEZAS DE RECAMBIO Y SOPORTE DE VENTA



UNINTERRUPTED CONNECTION WITH WEB PLATFORM

WEB PLATFORMU İLE KESİNTİSİZ BAĞLANTI

CONEXIÓN PERMANENTE CON LAS PLATAFORMA WEB

CNC MACHINING CENTER (FLAT TABLE GROUP)

CNC İŞLEME MERKEZİ (DÜZ TABLA GRUBU)

CENTRO DE PROCESAMIENTO CNC (GRUPO DE PLATAFORMA PLANA)

ULTRA
SERIES U



▪ RAPTOR ULTRA



▪ EXTREME ULTRA

PRO
SERIES P

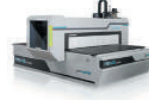

▪ SUPER NOVA



▪ FLEXA PRO

CNC MACHINING CENTER (CONSOLE TABLE GROUP)

CNC İŞLEME MERKEZİ (KONSOL TABLA GRUBU)

CENTRO DE PROCESAMIENTO CNC (GRUPO DE PLATAFORMA DE CONSOLAS)

ULTRA
SERIES U



▪ VEGA 5X

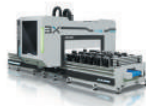

▪ VEGA ULTRA

PRO
SERIES P



▪ VEGA 5X PRO

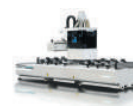

▪ VEGA PRO

CNC DRILLING MACHINES

CNC DELİK MAKİNELERİ

MÁQUINAS DE AGUJEERO CNC

ULTRA
SERIES U



▪ GO! ULTRA

PRO
SERIES P



▪ GO! 1300
▪ GO! 1300 M
▪ GO! 1300 M ATC



▪ SIRIUS 1300
▪ SIRIUS 1300 M
▪ SIRIUS 1300 M ATC

BEAM SAW MACHINES

PANEL EBATLAMA MAKİNELERİ

SECCIONADORAS

ULTRA
SERIES U



▪ ALPHA PS 05
▪ ALPHA PS 06



▪ ALPHA PS 03
▪ ALPHA PS 04

PRO
SERIES P



▪ BETA PS 03
▪ BETA PS 04

EDGE BANDING MACHINES

KENAR BANTLAMA MAKİNELERİ

CANTEODORAS MONOLATERALES AUTOMÁTICAS

ULTRA
SERIES U

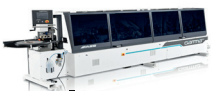

▪ GAMMA ULTRA

PRO
SERIES P



▪ GAMMA MX



▪ PRIMA 6M
▪ PRIMA 5M

WOODWORKING MACHINES



www.aesgroup.com.tr

AES HEADQUARTER

NOSAB Şeftali Cd.
118. Sk. No: 4 Nilüfer
16140 Bursa / TÜRKİYE
Tel : +90 224 443 33 90
Fax : +90 224 443 29 65
info@aesgroup.com.tr
www.aesgroup.com.tr

AES EUROPE BVBA

Kruisbosstraat
2b2-6186, 3740
Bilzen / BELGIUM
Tel : +32 89 81 1505
Fax : +32 89 81 1505
info@aesgroupeurope.com
www.aesgroupeurope.com

AES AMERICA INC.

4508-B Westinghouse
Blvd. Charlotte, 28273
NC USA
Tel : +1 704 817 7037
Fax : +1 704 817 7036
info@aesgroupamerica.com
www.aesgroupamerica.com